

KOENIG & BAUER

# ttPRINT – Thermal transfer coding



we're on it.

EN



# We live „Made in Germany“

For over 45 years we have been developing and manufacturing high quality coding technology products at our site in Veitshöchheim, Germany. Our focus is on first-class quality, outstanding performance and all this in combination with unbeatable reliability. We're on it.

**Uncompromisingly reliable.**  
**Coding**  
**with outstanding flexibility**  
**from printing to integration.**

Thermal transfer printers (TTO) are ideal for high-resolution print quality on flexible packaging materials such as tubular bags, tray seals, films, folding boxes and labels.

ttPRINT printers are designed for installation in labelling and packaging machines in any application. The comprehensive Koenig & Bauer Coding portfolio offers the right printing system for your needs in consideration of your specific coding requirements.

## Versatile, irrespective of industry

### Sweets & savoury snacks

Print just-in-time expiration dates, batch numbers, and codes on your product packaging such as tubular bags, tray seals, foils, folding boxes, and labels. If required, you can easily add your special coding campaigns.



### Foods

Enjoy unrestricted flexibility with coding directly at the manufacturing location, for instance on moulding or thermoforming machines. Variable data printing adjusts directly to your coding needs, including multi-lane printing and cyclical printing.



### Fresh foods

Down to the time of a second, coding of your packaging ensures you always have optimal traceability for your products. Create large-format print images – such as ingredient lists – and print them in high resolution and at high speed.



ttPRINT printers code perfectly in many industries and on a wide variety of materials and surfaces.



### Soft drinks and pouches

The perfect print image for your code on flexible packaging foil integrates seamlessly into your product design for brand positioning.



### Cosmetics and drugstore items

Precise and elegant coding with thermal transfer printing goes hand in hand with your high-quality brand design. Master your label and packaging coding with distinction.



### Pharmaceuticals

Synchronise frequently changing datasets from your database with the printer. Always print up to date alpha-numeric characters and 1D and 2D codes and secure the process for your track & trace requirements.

# 50 device variations

guarantee a wide range  
of different applications

Simple handling and excellent operational security provide an

# uptime > 99%

In comparison to other  
technologies, low equipment  
investments and inexpensive  
colour foils generate

# > 30% savings

**Would you like to integrate your printer into your packaging machine?**

The ttPRINT is very well suited for cycled and continuous production systems such as horizontal/vertical tubular bag machines, and thermoforming and tray sealing systems. Standard brackets are designed for any common packaging and labelling machine.

**Do you require economical investments for your coding?**

With ttPRINT, you'll receive a perfect printed image and reduce consumable costs thanks to the foil saving feature integrated into the printer. This increases your number of potential prints, and delays replacement of your ink ribbon.

# In a nutshell.

**Would you like to handle large-format printing – such as ingredients lists – with outstanding quality?**

The ttPRINT offers print shop quality printing at 300 dpi resolution. Print lists of ingredients by yourself on your tubular bags. Reach new levels of flexibility and save money by reducing your warehousing costs.

**Are you looking for more flexibility in your print image designs?**

Whether you want to print dates, times, counter functions, graphics, logos, symbols, or codes – print with precise detail and excellent reliability. The variety of printer variations available offers the best performance for any application.

**Do you maintain production facilities domestically and abroad?**

We offer a competent service and engineering team worldwide. Our international organisation receives outstanding ratings in our customer surveys for its handling of globally networked applications.

**Do you want to integrate your coding into your network?**

With the right interfaces, it's easy to integrate and monitor the ttPRINT using your company's own network. Send your printed image to your Koenig&Bauer Coding ttPRINT from any PC.

# Technical data ttPRINT models



	ttPRINT 53	ttPRINT 107	ttPRINT 128
<b>Print</b>			
Print resolution	300 dpi	300 dpi	300 dpi
<b>Intermittent printing</b>			
Print surface (L x W)	53.3 mm x 75 mm	106.6 mm x 75 mm	128 mm x 75 mm
Print speed	50 - 600 mm/second	50 - 600 mm/second	50 - 600 mm/second
<b>Continuous printing</b>			
Print surface (L x W)	53.3 mm x 6.000 mm	106.6 mm x 3.000 mm	128 mm x 3.000 mm
Print speed	50 - 800 mm/second	50 - 600 mm/second	50 - 450 mm/second
<b>Ribbon</b>			
Ribbon length	900 m	600 m	450 m
Roll diameter max.	98 mm	82 mm	75 mm
Ribbon width max.	55 mm	110 mm	130 mm
Ribbon design (coloured side)	inside / outside (option)	inside / outside (option)	inside / outside (option)
Exchange cassettes	✓	✓	✓
Automatic ribbon save function	✓	✓	✓
<b>Device variations</b>			
	right / left	right / left	right / left
<b>Safety</b>			
Protective class	IP 20 / (IP 65 optional)	IP 20 / (IP 65 optional)	IP 20 / (IP 65 optional)
<b>Dimensions (H x W x L; mm)</b>			
Printing mechanism	204 x 182 x 235 mm, 9.5 kg	204 x 182 x 290 mm, 11 kg	204 x 182 x 310 mm, 11.7 kg
Control unit	251 x 207 x 97 mm, 5.5 kg	251 x 207 x 97 mm, 5.5 kg	251 x 207 x 97 mm, 5.5 kg



Thermal transfer printing with ttPRINT printers fulfils all your needs for reliability, ease of operation, design, and controlling. You receive brilliant results and excellent flexibility. Our portfolio includes highly reliable equipment for your applications.

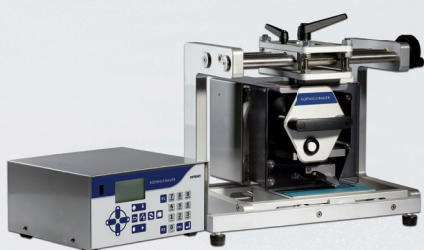

**ttPRINT XS**

300 dpi

53.3 mm x 40 mm

50 - 400 mm/second

53.3 mm x 3,000 mm

50 - 400 mm/second

600 m

82 mm

55 mm

inside / outside

-

✓

right / left

IP 20

190 x 180 x 208 mm, 6 kg

242 x 117 x 220 mm, 3.8 kg

**TT-ML 53**

300 dpi

53.3 mm x up to 630 mm

50 - 500 mm/second

600 m

85 mm

55 mm

inside / outside

-

✓

right / left

IP 20

188 x 370 - 860 x 265/320/340 mm, 9 - 16 kg

127 x 287 x 250 mm, 4,5 kg

**TT-ML 107**

300 dpi

106.6 mm x up to 630 mm

50 - 500 mm/second

600 m

85 mm

110 mm

inside / outside

-

✓

IP 20

**TT-ML 128**

300 dpi

128 mm x up to 630 mm

50 - 500 mm/second

600 m

85 mm

130 mm

inside / outside

-

✓

IP 20

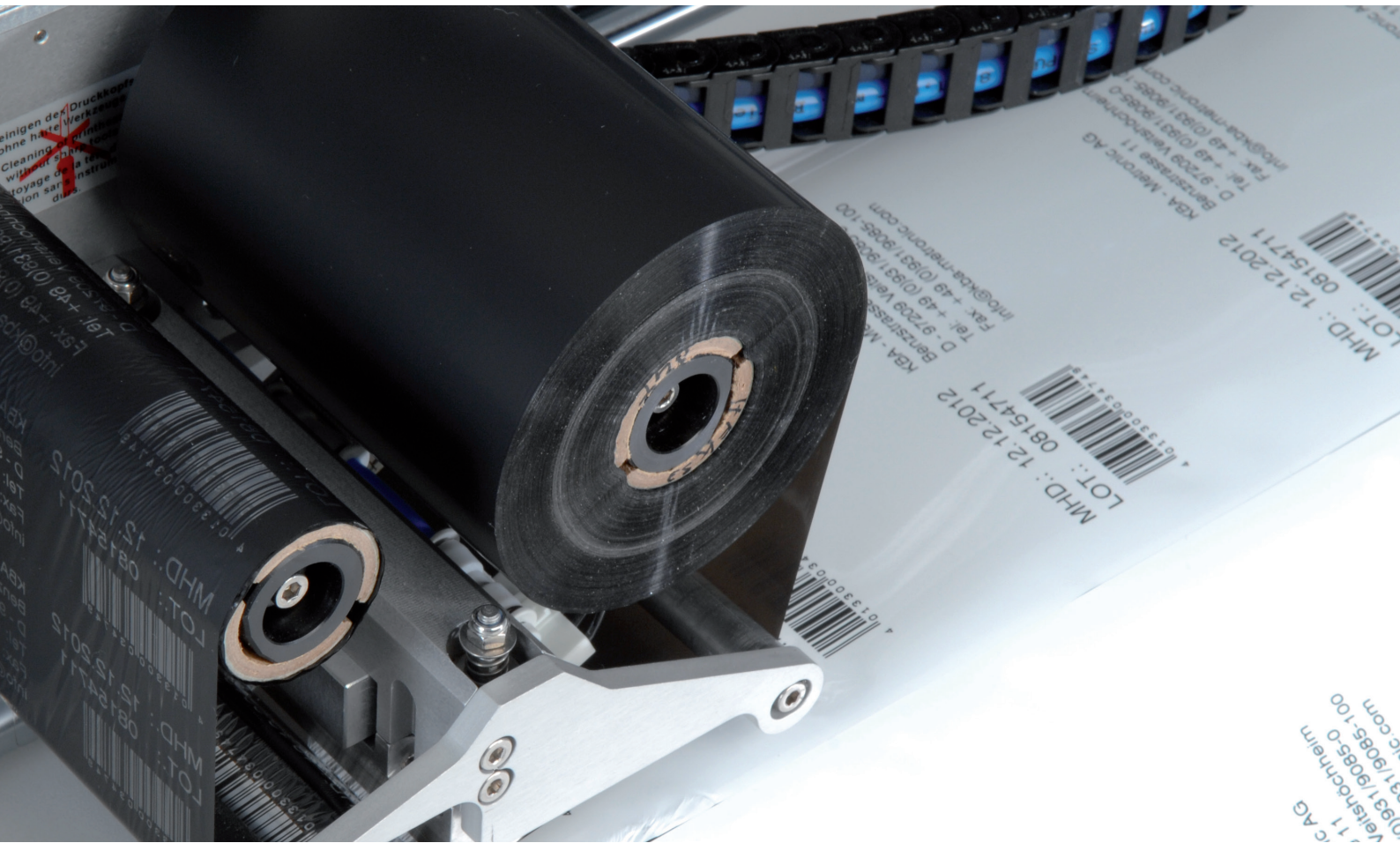

# Easy integration into labelling and packaging machines

Highly developed details and practical accessories  
make your coding even better

### Exchange cassettes

- for quick foil exchanges
- offer true flexibility for a wide variety of foil colours – including specialised colours
- simplify handling
- shorten your set-up times

### Protection class IP 65

Optimal protection against dust and splash water offered by Option IP 65 for ttPRINT 53, 107 and 128. Simply exchange the colour ribbon cassette for a cleaning cassette to clean the device with water jets.

The exchange can be completed in a few seconds. The electronics are protected with a separately secured controller.

### Standardised mounting frames

For simple integration into current packaging and labelling machines, a wide variety of widths up to 1,000 mm are available in the standard version. We can also manufacture customer-specific mounting frames upon request.

### Software

- Different software programs can be used for controlling, including Labelstar Office, Nice Label, Codesoft, etc.
- ConfigTool configuration software
- Windows printer drivers (WIN7, WIN8, Win 8.1, WIN 10)
- Zebra simulation program (ZPL)



Supplement your ttPRINT thermal transfer printer with practical accessories



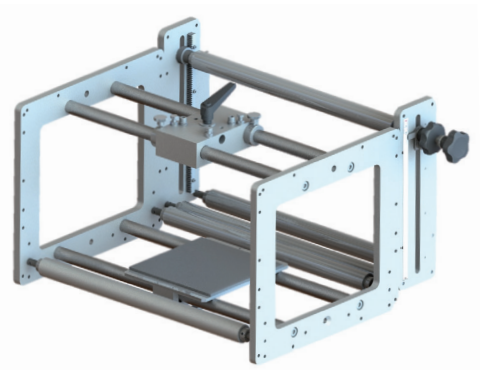

Controller IP 65





Standardised mounting frames up to 1,000 mm width

# More freedom in coding

EXD, batch, LOT,  
Plain text

	11.11.2020	Part.No.: 47110823899 LOT: 2
	11.11.2040	EXP: 01.01.2031
	1234567890	LOT: S2 3911 11:52

1D and 2D codes

	GTIN: 07046261398572 Batch: Koenig & Bauer EXP: 130331 S/N: 19067811811	 4 711081 547112
---	--	--

Logos and symbols

			
---	---	---	--

QR codes

	<p>Koenig &amp; Bauer Coding GmbH coding.koenig-bauer.com T: +49 931 9085 0 F: +49 931 9085 100 info-coding@koenig-bauer.com</p>
---	--

Custom typeface,  
Ingredients

Koenig & Bauer Alentania LOT: 16122	<p><b>DÜNNOFISCH</b> </p> <p>100 mg Dünnofleisch</p>		
---	---	--	---

## Genieserbrot mit Puten-Fleischkäse

Weizenmischbrot mit Puten-Fleischkäse, Honig-Senfauce und Gewürzgurken, tiefgefroren

Zutaten:



Weizenmischbrot 55% (Weizenmehl, Trinkwasser, Roggenmehl, Kartoffelpüreeflocken, Roggensauerteig, Roggenvollkornschrot, jodiertes Speisesalz, Hefe, Gerstenmalzmehl, Dextrose, Weizenröstmalmehl)  
Puten-Fleischkäse 23% (Putenfleisch, Putenfett, Putenhaut, Trinkwasser, Speisesalz, Gewürze, Dextrose, Glukosesirup, Natriumnitrit, Gewürzextrakte, Stabilisatoren Natriumcitrat, Diphosphate)  
Honig-Senfauce 22% Frischkäse, Trinkwasser, Sahne, Rapsöl, Brantweinessig, Erbsenstärke, Zucker.



**KOENIG & BAUER** STERILE R  Use once CE



Urether catheter  
Ureterkatheter  
Sonde urétérale  
Catetere ureterale  
Sonda ureteral

**LOT** 01/2020/0101/16:32  
 **01.01.2040**  
 **01.01.2020**



Serialität nur bei unbeschädigter und ungeöffneter Verpackung. Lichtgeschützt, sauber, trocken und kühl lagern.

Contents sterile providing pack is undamaged or unopened. Stor in clean dry conditions away from heat and light. Caution: Federal Law restricts this device to sale by, or on the order of, a physican. For USA and Canada only.



**Print sample TT-ML 107**

TT-ML with the “multi-web” printing function is ideal for variable coding of multiple small products or for applications with large-surface printing (such as lists of ingredients).

**KOENIG & BAUER** STERILE R  Use once CE



Urether catheter  
Ureterkatheter  
Sonde urétérale  
Catetere ureterale  
Sonda ureteral

**LOT** 02/2020/0101/16:32  
 **01.01.2040**  
 **01.01.2020**





Serialität nur bei unbeschädigter und ungeöffneter Verpackung. Lichtgeschützt, sauber, trocken und kühl lagern.

Contents sterile providing pack is undamaged or unopened. Stor in clean dry conditions away from heat and light. Caution: Federal Law restricts this device to sale by, or on the order of, a physican. For USA and Canada only.

**KOENIG & BAUER** STERILE R  Use once CE



Urether catheter  
Ureterkatheter  
Sonde urétérale  
Catetere ureterale  
Sonda ureteral

**LOT** 03/2020/0101/16:32  
 **01.01.2040**  
 **01.01.2020**





Serialität nur bei unbeschädigter und ungeöffneter Verpackung. Lichtgeschützt, sauber, trocken und kühl lagern.

Contents sterile providing pack is undamaged or unopened. Stor in clean dry conditions away from heat and light. Caution: Federal Law restricts this device to sale by, or on the order of, a physican. For USA and Canada only.

**KOENIG & BAUER** STERILE R  Use once CE



Urether catheter  
Ureterkatheter  
Sonde urétérale  
Catetere ureterale  
Sonda ureteral

**LOT** 04/2020/0101/16:32  
 **01.01.2040**  
 **01.01.2020**





Serialität nur bei unbeschädigter und ungeöffneter Verpackung. Lichtgeschützt, sauber, trocken und kühl lagern.

Contents sterile providing pack is undamaged or unopened. Stor in clean dry conditions away from heat and light. Caution: Federal Law restricts this device to sale by, or on the order of, a physican. For USA and Canada only.

**KOENIG & BAUER** STERILE R  Use once CE



Urether catheter  
Ureterkatheter  
Sonde urétérale  
Catetere ureterale  
Sonda ureteral

**LOT** 05/2020/0101/16:32  
 **01.01.2040**  
 **01.01.2020**





Serialität nur bei unbeschädigter und ungeöffneter Verpackung. Lichtgeschützt, sauber, trocken und kühl lagern.

Contents sterile providing pack is undamaged or unopened. Stor in clean dry conditions away from heat and light. Caution: Federal Law restricts this device to sale by, or on the order of, a physican. For USA and Canada only.

**KOENIG & BAUER** STERILE R  Use once CE



Urether catheter  
Ureterkatheter  
Sonde urétérale  
Catetere ureterale  
Sonda ureteral

**LOT** 06/2020/0101/16:32  
 **01.01.2040**  
 **01.01.2020**



Serialität nur bei unbeschädigter und ungeöffneter Verpackung. Lichtgeschützt, sauber, trocken und kühl lagern.

Contents sterile providing pack is undamaged or unopened. Stor in clean dry conditions away from heat and light. Caution: Federal Law restricts this device to sale by, or on the order of, a physican. For USA and Canada only.



## 5 good reasons

# to choose ttPRINT

01

Low consumption combined with low prices means you save money.

02

Excellent uptime of over 99 % provides true production reliability.

03

Easy integration into all current labelling and packaging machines provides more flexibility.

04

A comprehensive portfolio of ribbons let you react flexible to customer requests and increases customer loyalty.

05

A competent global sales and service team supports you at any time.

# ttPRINT

## at a glance

### General technical data

#### Interfaces

- Ethernet 10/100 Base T, LPD RawIP-Printing, DHCP, HTTP, FTP
- Serial RS232
- USB for keyboard or memory stick
- Digital I/O port (foil ends, print head open, ...)

#### Operation

- 7" touch display (ttPRINT 53, 107, 128 only)
- User-friendly graphic operating interface
- Configurable user rights
- Labelstar Office design software, Nicelabel
- Windows printer drivers

#### Text composition

- Counter (with auto-stop function) and time functions
- DataMatrix, QR code, Barcode, DotCode
- Characters and logos (BMP format)
- Data fields (can be filled via interface)
- Prompted fields (request input)
- True Type Fonts (international language and character diversity)
- Bitmap fonts
- Vector fonts

#### Product features

- Automatic ribbon save function
- Optional protection class IP 65 (protected against dust and splash water)
- User management

#### Power requirements

- Mains voltage (AC) 230 V / 1,5 A - 115 V / 3A, 345 VA
- Air connection: 3 - 5 bar, ø 8 mm
- Ambient conditions: 5 - 40 °C, max. 80 % humidity

**Koenig & Bauer Coding GmbH**  
Benzstraße 11  
97209 Veitshöchheim, Germany

T +49 931 9085-0  
F +49 931 9085-100  
info-coding@koenig-bauer.com

[coding.koenig-bauer.com](http://coding.koenig-bauer.com)

Text excerpts and illustrations may only be used with the permission of Koenig & Bauer Coding GmbH. Illustrations may show special equipment which is not included in the basic price of the systems. The manufacturer reserves the right to make technical and design changes.



10/2018-e 1039.2565  
Printed in Germany